

SURGE-TRAP® PLUGGABLE

SURGE PROTECTIVE DEVICE

DIN-RAIL PLUGGABLE SPD FOR ANSI/UL 1449 TYPE 1 AND 2 APPLICATIONS



Surge-Trap® Pluggable Surge Protective Device (SPD) is a no-fuse, fail-safe surge suppressor featuring Mersen's patented TPMOV® technology inside. UL 1449 4th Edition approved, it is DIN-rail mountable featuring a fail-safe self-protected design, visual indicator, and a small footprint. A remote indicator option provides status to critical control circuitry. The Surge-Trap Pluggable SPD has a high short circuit rating and a thermally protected MOV, which eliminates the need for additional overcurrent protection devices.

FEATURES AND BENEFITS:

- Easy installation or retrofit
- DIN-rail mountable
- Fail-safe, self-protected design
- Remote indicator
- Visual indicator
- IP20 finger-safe design
- Small footprint
- No additional overcurrent protection devices required
- Easy to replace modules
- 2-year warranty

RATINGS:

- **Volts (U_n):** 120-690VAC
- **Nominal Discharge Current Rating (I_n):** 10-20kA
- **Surge Capacity:** 50kA
- **Short-Circuit Current Rating (SCCR):** 200kA

APPROVALS:

- ANSI/UL 1449 4th Edition, Type 1 Component Assembly SPD, File E210793
- ANSI/IEEE C62.41.1, C62.41.2, C62.45
- RoHS Compliant



GENERAL PRODUCT SPECIFICATIONS

Mounting:	35mm DIN-Rail	Operating & Storage Temperature:	- 40°C to + 85°C
Wire Range:	6-14AWG Solid / Stranded CU	Visual End of Life Indicator:	RED = End of Life
Terminal Torque:	14.75 lbs-in	Remote End of Life Indicator:	NO/NC Dry Contact
Degree of Protection:	IP 20	Frequency:	50-60 Hz
Flammability:	UL94 V0		

1-POLE, SINGLE-PHASE, 2-WIRE

CATALOG NUMBER	NOMINAL VOLTAGE (VAC)	MAXIMUM CONTINUOUS OPERATING VOLTAGE (MCOV, VAC)				VOLTAGE PROTECTION RATING (VPR, VAC)				REPLACEMENT PLUG	I _n (kA)
		L-N	L-G	N-G	L-L	L-N	L-G	N-G	L-L		
STP1201PGM	120	180	180	-	-	600	600	-	-	SP180U	20
STP2301PGM	240	275	275	-	-	900	900	-	-	SP275U	20
STP2771PGM	277	320	320	-	-	1000	1000	-	-	SP320U	20
STP3471PGM	347	420	420	-	-	1500	1500	-	-	SP420U	10
STP6001PGM*	600	650	650	-	-	2000	2000	-	-	SP660U	10

*SCCR = 42kA

2-POLE, SPLIT-PHASE, 3-WIRE

CATALOG NUMBER	NOMINAL VOLTAGE (VAC)	MAXIMUM CONTINUOUS OPERATING VOLTAGE (MCOV, VAC)				VOLTAGE PROTECTION RATING (VPR, VAC)				REPLACEMENT PLUG	I _n (kA)
		L-N	L-G	N-G	L-L	L-N	L-G	N-G	L-L		
STP240SPGM	120/240	180	180	-	360	600	600	-	1200	SP180U	20
STP480SPGM	240/480	275	275	-	550	900	900	-	1800	SP275U	20

3-POLE, 3-PHASE DELTA, 4-WIRE

CATALOG NUMBER	NOMINAL VOLTAGE (VAC)	MAXIMUM CONTINUOUS OPERATING VOLTAGE (MCOV, VAC)				VOLTAGE PROTECTION RATING (VPR, VAC)				REPLACEMENT PLUG	I _n (kA)
		L-N	L-G	N-G	L-L	L-N	L-G	N-G	L-L		
STP2403PDGM	240	275	275	-	550	900	900	-	1800	SP275U	20
STP4803PDGM	480	550	550	-	1100	1800	1800	-	3000	SP550U	10

3-POLE, 3-PHASE WYE, 4-WIRE

CATALOG NUMBER	NOMINAL VOLTAGE (VAC)	MAXIMUM CONTINUOUS OPERATING VOLTAGE (MCOV, VAC)				VOLTAGE PROTECTION RATING (VPR, VAC)				REPLACEMENT PLUG	I _n (kA)
		L-N	L-G	N-G	L-L	L-N	L-G	N-G	L-L		
STP2083PYGM	120/208	180	180	-	360	600	600	-	1200	SP180U	20
STP4803PYGM	277/480	320	320	-	640	1000	1000	-	1800	SP320U	20
STP6003PYGM	347/600	420	420	-	840	1500	1500	-	2500	SP420U	10
STP6903PYGM	400/690	440	440	-	880	1500	1500	-	2500	SP440U	20

4-POLE, 3-PHASE WYE, 5-WIRE, INCLUDING N-G MODE

CATALOG NUMBER	NOMINAL VOLTAGE (VAC)	MAXIMUM CONTINUOUS OPERATING VOLTAGE (MCOV, VAC)				VOLTAGE PROTECTION RATING (VPR, VAC)				REPLACEMENT PLUG		I _n (kA)
		L-N	L-G	N-G	L-L	L-N	L-G	N-G	L-L	L1, L2, L3	N-G	
STP2083PYM	120/208	180	180	180	360	600	1200	600	1200	SP180U	SP180U	20
STP4803PYM	277/480	320	500	180	640	1000	1500	600	1800	SP320U	SP180U	20
STP6003PYM	347/600	420	695	275	840	1500	2000	600	2500	SP420U	SP275U	10
STP6903PYM	400/690	440	760	320	880	1500	2000	1000	2500	SP440U	SP320U	20

4-POLE, 3-PHASE DELTA HIGH-LEG, 5-WIRE, INCLUDING N-G MODE

CATALOG NUMBER	NOMINAL VOLTAGE (VAC)	MAXIMUM CONTINUOUS OPERATING VOLTAGE (MCOV, VAC)				VOLTAGE PROTECTION RATING (VPR, VAC)				REPLACEMENT PLUG			I _n (kA)
		L-N	L-G	N-G	L-L	L-N	L-G	N-G	L-L	L1, L3	L2	N-G	
STP2403PHM	120/240	360	180	455	275	1200	600	1500	900	SP180U	SP275U	SP180U	20
STP4803PHM	240/480	550/455	275/180	825/730	550	1.8k/1.5k	900/600	2.5k/2.0k	1800	SP275U	SP550U	SP180U	10

DIMENSIONS - STP SERIES

POLES	A	
	IN	MM
1 Pole	0.71	18.03
2 Pole	1.42	36.06
3 Pole	2.13	54.1
4 Pole	2.84	72.13

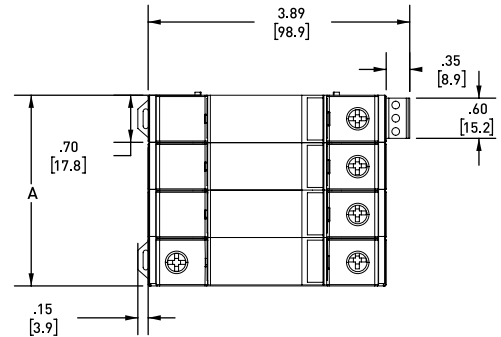
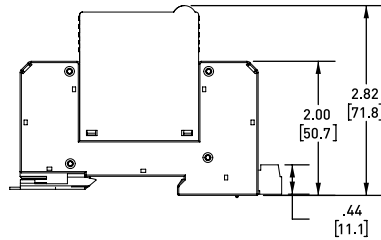

DIMENSIONS - ST SERIES

POLES	A	
	IN	MM
1 Pole	0.7	17.8
2 Pole	1.39	35.5
3 Pole	2.1	53.3
4 Pole	2.8	71

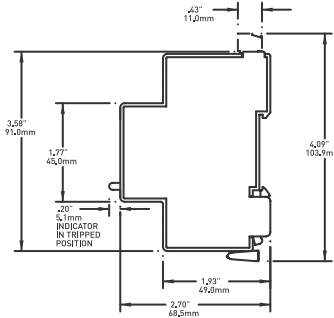
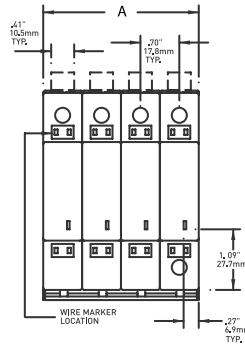

WIRING DIAGRAMS

1-POLE, SINGLE-PHASE, 2-WIRE

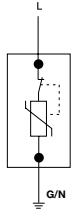

2-POLE, SPLIT-PHASE, 3-WIRE

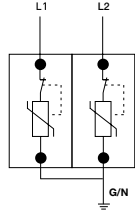

3-POLE, 3-PHASE DELTA, 3-WIRE

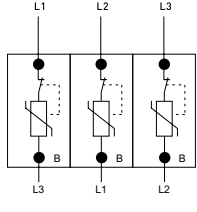

3-POLE, 3-PHASE DELTA, 3-PHASE WYE, 4-WIRE

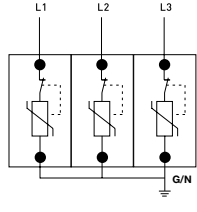

4-POLE, 3-PHASE WYE, 5-WIRE

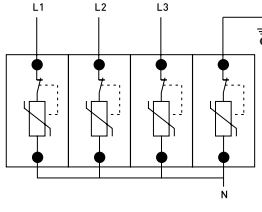

4-POLE, 3-PHASE DELTA HIGH-LEG, 5-WIRE

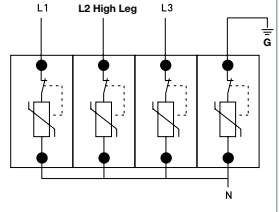

SINGLE PHASE 2 WIRE + GROUND

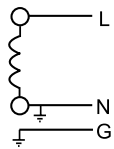

SPLIT PHASE 3 WIRE + GROUND

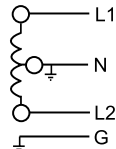

3 PHASE DELTA 3 WIRE + GROUND

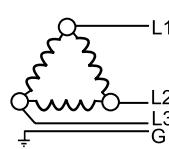

3 PHASE WYE 4 WIRE + GROUND

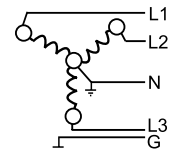

REMOTE STATUS INDICATOR

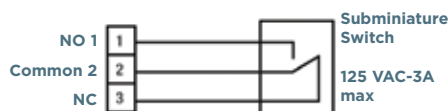
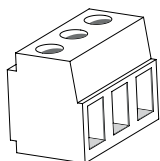

Signal Wire Range

#16 to #30 AWG

Terminal Torque

2.2 lb-in

Cont. between Comm + NO

Product Offline, Not Protected

Cont. between Comm + NC

Product Online, Protected

STP SERIES: REMOTE INDICATION COMES STANDARD WITH ALL STP, SURGE-TRAP PLUGGABLE UNITS.

ST SERIES: FOR REMOTE INDICATION, ADD "M" TO THE END OF THE CATALOG NUMBER. FOR EXAMPLE, ST4803PYGM.