

## Lay-In Wireway Type 12 Data Sheet



### Application

- Houses runs of control and power cable
- Protects against circulating dust, falling dirt and dripping noncorrosive liquids

### Standards

- UL 870 listed, unless noted
- CSA C22.2 No. 26 certified, unless noted
- Conforms to NEMA standard for Type 12

### Finish

- Wash and phosphate undercoat
- ANSI 61 gray painted finish
- Hardware and latches are zinc plated

### Accessories

- Touch-up paint
- See Accessories section

### Construction

- Wireway body and cover are fabricated from (14) gauge steel
- Flanges are (10) gauge steel
- All continuous welded seams are finished smooth
- External and internal edges are rounded to prevent injury or damage to cable
- Covers are secured to the wireway and fitting body with heavy duty butt hinges and quick-release latches
- Covers have a fixed, oil-resistant gasket
- An oil-resistant gasket is provided for installation between flanges
- All covers and sealing plates can be hinged completely open or removed to allow for continuous lay-in cable feed
- All straight sections and fittings are furnished with sealing plate kits (see pages 26-30)

### Discount Schedule: C2

### Subclass: D90

**Notes:** We can provide special sizes, finishes and other modifications. Consult the factory for your special requirements.

## Lay-In Wireway Type 12 Illustration Sheet

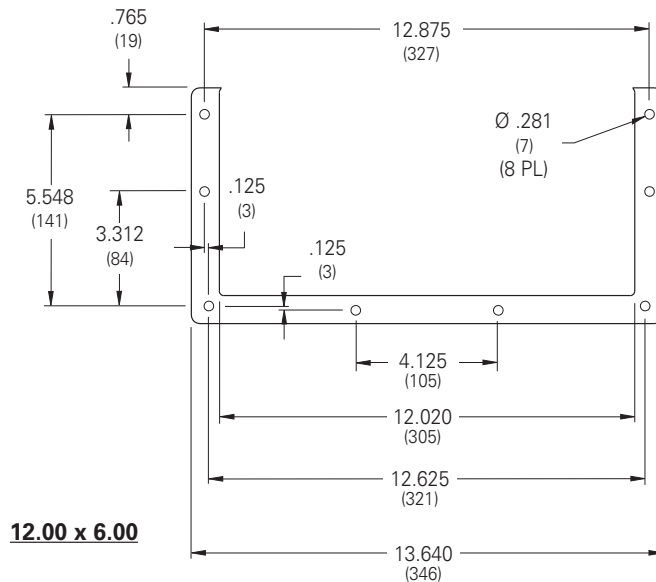
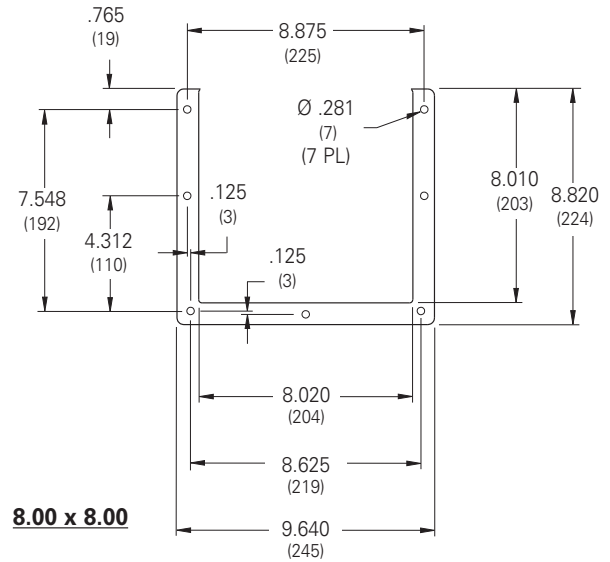
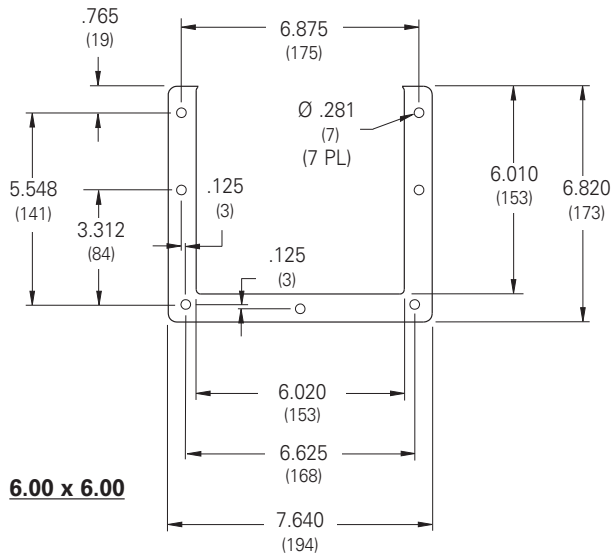
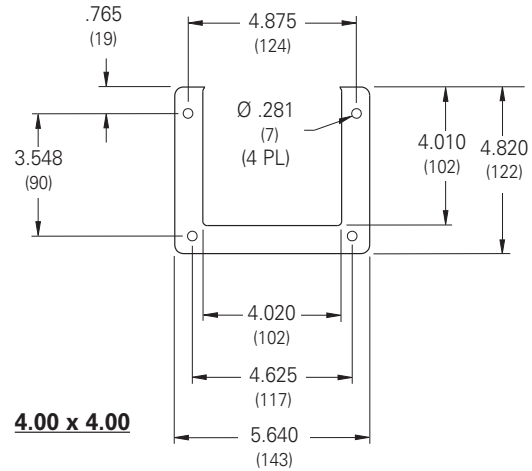
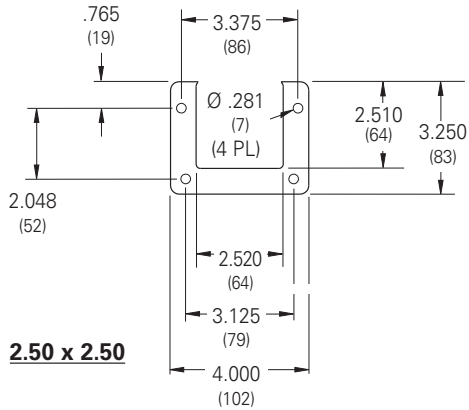

### Flange Details

**Notes:** Dimensions are in inches. Millimeters shown are for reference only. Data subject to change without notice.

## Lay-In Wireway Type 12

### Illustration Sheet and Catalog Number

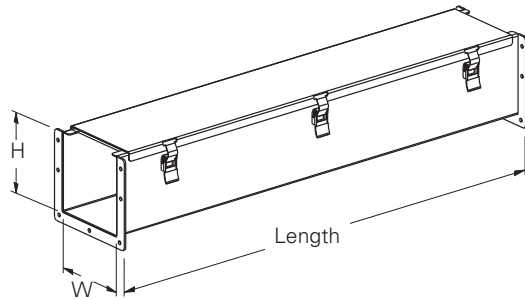

#### Straight Section

- Includes (1) sealing plate kit

Catalog Number	Size	H		W	
		in.	mm	in.	mm
22(*)-12LW	2.5 x 2.5	2.50	64	2.50	64
44(*)-12LW	4 x 4	4.00	102	4.00	102
66(*)-12LW	6 x 6	6.00	152	6.00	152
88(*)-12LW	8 x 8	8.00	203	8.00	203
126(*)-12LW	12 x 6	6.00	152	12.00	305

(\*) Insert for length **04** = 4", **06** = 6", **12** = 12", **24** = 24", **36** = 36", **48** = 48", **60** = 60", **120** = 120".

For	Actual Length	
	in.	mm
4	3.94	100
6	5.94	151
12	11.94	303
24	23.94	608
36	35.94	913
48	47.94	1218
60	59.94	1522
120	119.94	3046

### Subclass: D90

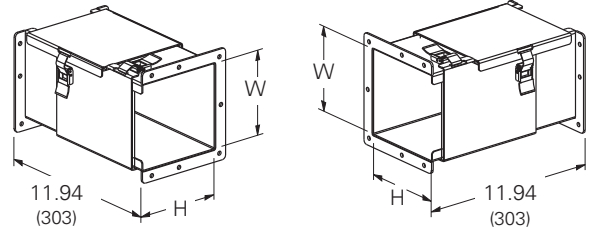

#### Transposition Wireway Sections

##### Clockwise (C)

- Includes (1) sealing plate kit

##### Counterclockwise (CC)

- Includes (1) sealing plate kit

Catalog Number	Size	H		W	
		in.	mm	in.	mm
22-12LTS(*)	2.5 x 2.5	2.50	64	2.50	64
44-12LTS(*)	4 x 4	4.00	102	4.00	102
66-12LTS(*)	6 x 6	6.00	152	6.00	152
88-12LTS(*)	8 x 8	8.00	203	8.00	203

(\*) Insert **C** for Clockwise  
Insert **CC** for Counterclockwise

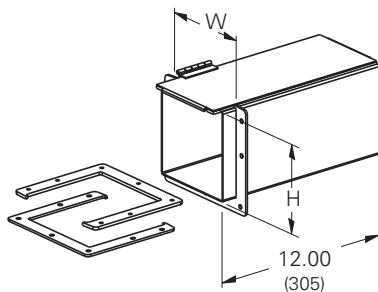

#### Telescopic Fitting, Lay-In

- Adjustable length from 1" to 7"
- Includes hardware
- No cutting or welding required

Catalog Number	Size	H		W	
		in.	mm	in.	mm
22-12LTF	2.5 x 2.5	2.32	59	2.32	59
44-12LTF	4 x 4	3.82	97	3.82	97
66-12LTF	6 x 6	5.82	148	5.82	148
88-12LTF	8 x 8	7.82	199	7.82	199
126-12LTF	12 x 6	5.82	148	11.82	300

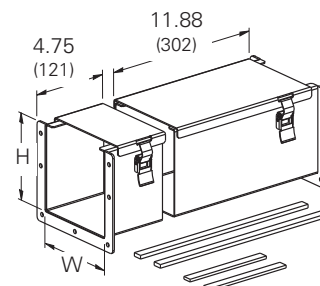

#### Cut-Off Fitting, Lay-In

- Includes (1) sealing plate kit
- Shorten body and cover to desired length and weld together, 9.50" minimum length

Catalog Number	Size	H		W	
		in.	mm	in.	mm
22-12LCF	2.5 x 2.5	2.50	64	2.50	64
44-12LCF	4 x 4	4.00	102	4.00	102
66-12LCF	6 x 6	6.00	152	6.00	152
88-12LCF	8 x 8	8.00	203	8.00	203
126-12LCF	12 x 6	6.00	152	12.00	305

**Notes:** Dimensions are in inches. Millimeters shown are for reference only. Data subject to change without notice.

# Cable & Wire Management

## Lay-In Wireway Type 12

### Illustration Sheet and Catalog Number

Subclass: D90

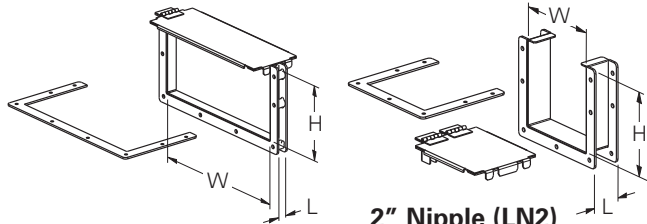

#### 1" Nipple (LN1)

- Includes hardware

#### 2" Nipple (LN2)

#### 3" Nipple (LN3)

- Includes hardware

Catalog Number	Size	H		W	
		in.	mm	in.	mm
22-12LN(*)	2.5 x 2.5	2.50	64	2.50	64
44-12LN(*)	4 x 4	4.00	102	4.00	102
66-12LN(*)	6 x 6	6.00	152	6.00	152
88-12LN(*)	8 x 8	8.00	203	8.00	203
126-12LN(*)	12 x 6	6.00	152	12.00	305

(\*) Insert **1** for 1" nipple (L=.938")  
 Insert **2** for 2" nipple (L=1.938")  
 Insert **3** for 3" nipple (L=2.938")

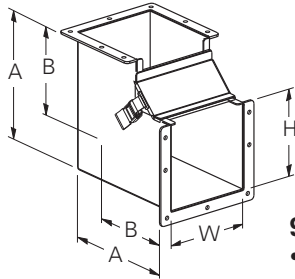

#### 90° Elbow, Inside Opening

- Includes (1) sealing plate kit

Catalog Number	Size	H		W		A		B	
		in.	mm	in.	mm	in.	mm	in.	mm
22-12LE9B	2.5 x 2.5	2.50	64	2.50	64	5.94	151	4.69	119
44-12LE9B	4 x 4	4.00	102	4.00	102	7.44	189	5.44	138
66-12LE9B	6 x 6	6.00	152	6.00	152	9.44	240	6.44	164
88-12LE9B	8 x 8	8.00	203	8.00	203	11.44	291	7.44	189
126-12LE9B	12 x 6	6.00	152	12.00	305	9.44	240	6.44	164

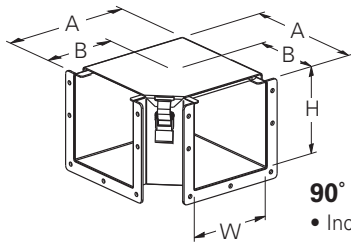

#### 90° Elbow, Top Opening

- Includes (1) sealing plate kit

Catalog Number	Size	H		W		A		B	
		in.	mm	in.	mm	in.	mm	in.	mm
22-12LE9A	2.5 x 2.5	2.50	64	2.50	64	5.25	133	4.00	102
44-12LE9A	4 x 4	4.00	102	4.00	102	6.75	171	4.75	121
66-12LE9A	6 x 6	6.00	152	6.00	152	8.75	222	5.75	146
88-12LE9A	8 x 8	8.00	203	8.00	203	10.75	273	6.75	171
126-12LE9A	12 x 6	6.00	152	12.00	305	14.75	375	8.75	222

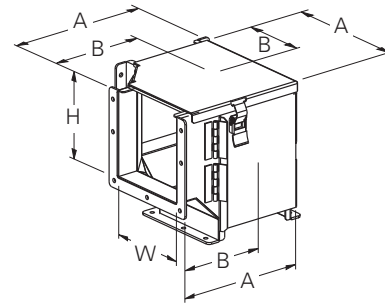

#### 90° Elbow, Outside-Top Opening

- Includes (2) sealing plate kits

Catalog Number	Size	H		W		A		B	
		in.	mm	in.	mm	in.	mm	in.	mm
22-12LE9AC	2.5 x 2.5	2.50	64	2.50	64	5.94	151	4.69	119
44-12LE9AC	4 x 4	4.00	102	4.00	102	7.44	189	5.44	138
66-12LE9AC	6 x 6	6.00	152	6.00	152	9.44	240	6.44	164
88-12LE9AC	8 x 8	8.00	203	8.00	203	11.44	291	7.44	189

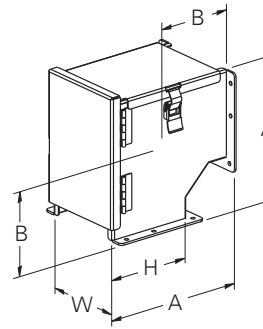

#### 90° Elbow, Outside Opening

- Includes (1) sealing plate kit

Catalog Number	Size	H		W		A		B	
		in.	mm	in.	mm	in.	mm	in.	mm
22-12LE9C	2.5 x 2.5	2.50	64	2.50	64	5.94	151	4.69	119
44-12LE9C	4 x 4	4.00	102	4.00	102	7.44	189	5.44	138
66-12LE9C	6 x 6	6.00	152	6.00	152	9.44	240	6.44	164
88-12LE9C	8 x 8	8.00	203	8.00	203	11.44	291	7.44	189
126-12LE9C	12 x 6	6.00	152	12.00	305	9.44	240	6.44	164

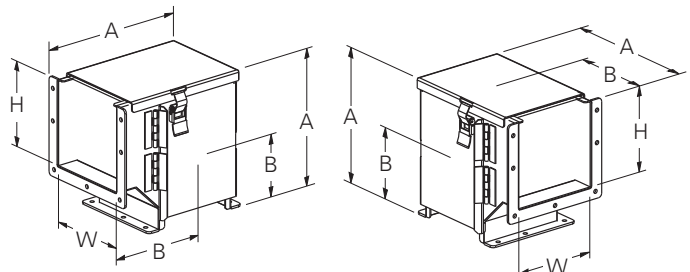

#### 90° Transposition Elbows

##### Clockwise (C)

- Includes (1) sealing plate kit

##### Counterclockwise (CC)

- Includes (1) sealing plate kit

Catalog Number	Size	H		W		A		B	
		in.	mm	in.	mm	in.	mm	in.	mm
22-12LE9T(*)	2.5 x 2.5	2.50	64	2.50	64	5.94	151	4.69	119
44-12LE9T(*)	4 x 4	4.00	102	4.00	102	7.44	189	5.44	138
66-12LE9T(*)	6 x 6	6.00	152	6.00	152	9.44	240	6.44	164
88-12LE9T(*)	8 x 8	8.00	203	8.00	203	11.44	291	7.44	189

(\*) Insert **C** for Clockwise, Insert **CC** for Counterclockwise

**Notes:** Dimensions are in inches. Millimeters shown are for reference only. Data subject to change without notice.

## Lay-In Wireway Type 12

### Illustration Sheet and Catalog Number

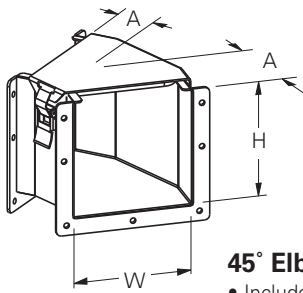

**45° Elbow, Top Opening**

- Includes (1) sealing plate kit

Catalog Number	Size	H		W		A	
		in.	mm	in.	mm	in.	mm
22-12LE45A	2.5 x 2.5	2.50	64	2.50	64	3.12	79
44-12LE45A	4 x 4	4.00	102	4.00	102	3.70	94
66-12LE45A	6 x 6	6.00	152	6.00	152	4.46	113
88-12LE45A	8 x 8	8.00	203	8.00	203	5.23	133
126-12LE45A	12 x 6	6.00	152	12.00	305	6.76	172

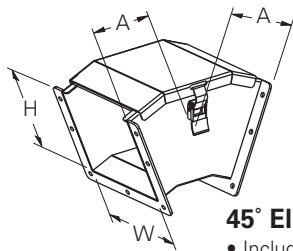

**45° Elbow, Outside Opening**

- Includes (1) sealing plate kit

Catalog Number	Size	H		W		A	
		in.	mm	in.	mm	in.	mm
22-12LE45C	2.5 x 2.5	2.50	64	2.50	64	2.65	67
44-12LE45C	4 x 4	4.00	102	4.00	102	3.51	89
66-12LE45C	6 x 6	6.00	152	6.00	152	3.91	99
88-12LE45C	8 x 8	8.00	203	8.00	203	4.24	108
126-12LE45C	12 x 6	6.00	152	12.00	305	3.91	89

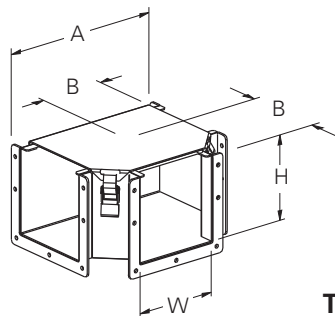

**Tee, Top Opening**

- Includes (2) sealing plate kits

Catalog Number	Size	H		W		A		B	
		in.	mm	in.	mm	in.	mm	in.	mm
22-12LTA	2.5 x 2.5	2.50	64	2.50	64	8.00	203	4.00	102
44-12LTA	4 x 4	4.00	102	4.00	102	9.50	241	4.75	121
66-12LTA	6 x 6	6.00	152	6.00	152	11.50	292	5.75	146
88-12LTA	8 x 8	8.00	203	8.00	203	13.50	343	6.75	171
126-12LTA	12 x 6	6.00	152	12.00	305	17.50	445	8.75	222

### Subclass: D90

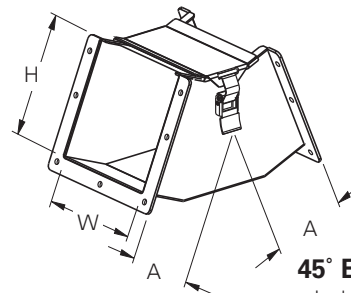

**45° Elbow, Inside Opening**

- Includes (1) sealing plate kit

Catalog Number	Size	H		W		A	
		in.	mm	in.	mm	in.	mm
22-12LE45B	2.5 x 2.5	2.50	64	2.50	64	3.70	94
44-12LE45B	4 x 4	4.00	102	4.00	102	4.28	109
66-12LE45B	6 x 6	6.00	152	6.00	152	5.04	128
88-12LE45B	8 x 8	8.00	203	8.00	203	5.81	148
126-12LE45B	12 x 6	6.00	152	12.00	305	5.04	128

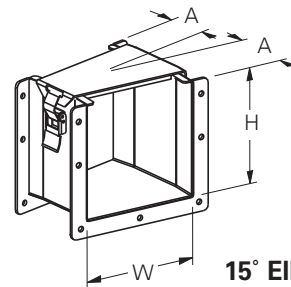

**15° Elbow, Top Opening**

- Includes (1) sealing plate kit

Catalog Number	Size	H		W		A	
		in.	mm	in.	mm	in.	mm
22-12LE15A	2.5 x 2.5	2.50	64	2.50	64	2.57	65
44-12LE15A	4 x 4	4.00	102	4.00	102	2.77	70
66-12LE15A	6 x 6	6.00	152	6.00	152	3.03	77
88-12LE15A	8 x 8	8.00	203	8.00	203	3.29	84
126-12LE15A	12 x 6	6.00	152	12.00	305	3.81	97

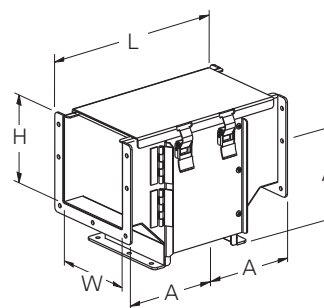

**Tee, Outside Opening**

- Includes (2) sealing plate kits

Catalog Number	Size	H		W		A		L	
		in.	mm	in.	mm	in.	mm	in.	mm
22-12LTC	2.5 x 2.5	2.50	64	2.50	64	4.69	119	9.38	238
44-12LTC	4 x 4	4.00	102	4.00	102	5.44	138	10.88	264
66-12LTC	6 x 6	6.00	152	6.00	152	6.44	164	12.88	314
88-12LTC	8 x 8	8.00	203	8.00	203	7.44	189	14.88	365

**Notes:** Dimensions are in inches. Millimeters shown are for reference only. Data subject to change without notice.

## Lay-In Wireway Type 12

### Illustration Sheet and Catalog Number

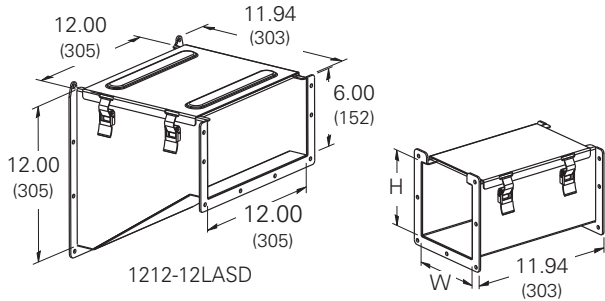

#### Adapters

- Includes (2) sealing plate kits

Catalog Number	Size	Competitor	H		W	
			in.	mm	in.	mm
22-12LAHW	2.5 x 2.5	Hoffman®† or Wiegmann®†	2.50	64	2.50	64
44-12LAHW	4 x 4		4.00	102	4.00	102
66-12LAHW	6 x 6		6.00	152	6.00	152
88-12LAHW	8 x 8		8.00	203	8.00	203
126-12LAHW	12 x 6		6.00	152	12.00	305
22-12LASD	2.5 x 2.5	Square D®†	2.50	64	2.50	64
44-12LASD	4 x 4		4.00	102	4.00	102
66-12LASD	6 x 6		6.00	152	6.00	152
88-12LASD	8 x 8		8.00	203	8.00	203
126-12LASD	12 x 6		6.00	152	12.00	305
22-12LAHM	2.5 x 2.5	Hammond Mfg.™†	2.50	64	2.50	64
44-12LAHM	4 x 4		4.00	102	4.00	102
66-12LAHM	6 x 6		6.00	152	6.00	152
88-12LAHM	8 x 8		8.00	203	8.00	203
126-12LAHM	12 x 6		6.00	152	12.00	305

† Marks are the property of their respective owners.

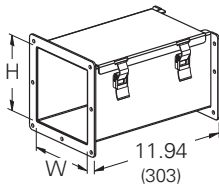

#### Lay-In to Feed Through Adapter

- Includes (1) sealing plate kit and (1) gasket kit

Catalog Number	Size	H		W	
		in.	mm	in.	mm
44-12LAFW	4 x 4	4.00	102	4.00	102
66-12LAFW	6 x 6	6.00	152	6.00	152
88-12LAFW	8 x 8	8.00	203	8.00	203

### Subclass: D90

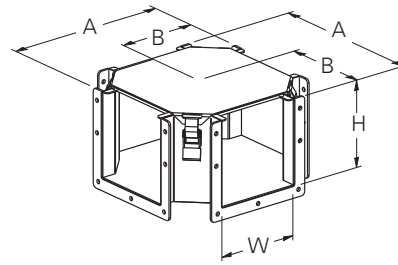

#### Cross, Top Opening

- Includes (3) sealing plate kits

Catalog Number	Size	H		W		A		B	
		in.	mm	in.	mm	in.	mm	in.	mm
22-12LC	2.5 x 2.5	2.50	64	2.50	64	8.00	203	4.00	102
44-12LC	4 x 4	4.00	102	4.00	102	9.50	241	4.75	121
66-12LC	6 x 6	6.00	152	6.00	152	11.50	292	5.75	146
88-12LC	8 x 8	8.00	203	8.00	203	13.50	343	6.75	171
126-12LC	12 x 6	6.00	152	12.00	152	17.50	445	8.75	222

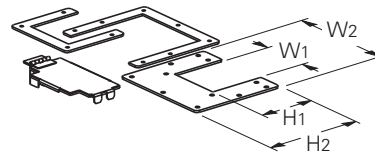

#### Reducer

- Includes hardware

Catalog Number	Size	H1		H2		W1		W2	
		in.	mm	in.	mm	in.	mm	in.	mm
4422-12LR	4 x 4 to 2.5 x 2.5	2.44	62	4.82	122	2.38	60	5.64	143
6644-12LR	6 x 6 to 4 x 4	3.94	100	6.82	173	3.88	99	7.64	194
8866-12LR	8 x 8 to 6 x 6	5.94	151	8.82	224	5.88	149	9.64	245
12644-12LR	12 x 6 to 4 x 4	3.94	100	6.82	173	3.88	99	13.64	346
12666-12LR	12 x 6 to 6 x 6	5.94	151	6.82	173	5.88	149	13.64	346

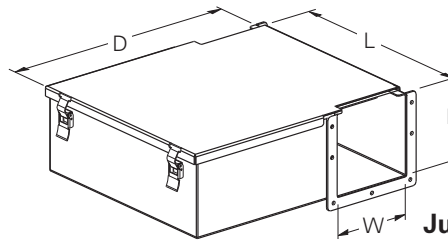

#### Junction Box

- Includes (1) junction box sealing plate kit and (1) of the following removable panels:  
 22-12LJB = AW108P  
 44-12LJB = AW1210P  
 66-12LJB = AW1412P  
 88-12LJB = AW1614P

Catalog Number	Size	H		W		L		D	
		in.	mm	in.	mm	in.	mm	in.	mm
22-12LJB	2.5 x 2.5	2.50	64	2.50	64	11.59	294	10.25	260
44-12LJB	4 x 4	4.00	102	4.00	102	13.59	345	14.00	356
66-12LJB	6 x 6	6.00	152	6.00	152	15.59	396	18.00	457
88-12LJB	8 x 8	8.00	203	8.00	203	17.59	447	22.00	559

**Notes:** Dimensions are in inches. Millimeters shown are for reference only. Data subject to change without notice.

## Lay-In Wireway Type 12

### Illustration Sheet and Catalog Number

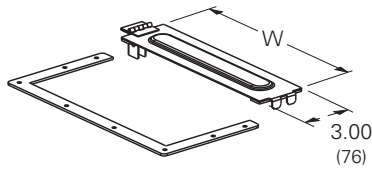

#### Sealing Plate, Flat

- Includes hardware

Catalog Number	Size	W	
		in.	mm
22-12LSP	2.5 x 2.5	2.50	64
44-12LSP	4 x 4	4.00	102
66-12LSP	6 x 6	6.00	152
88-12LSP	8 x 8	8.00	203
126-12LSP	12 x 6	12.00	305

### Subclass: D90

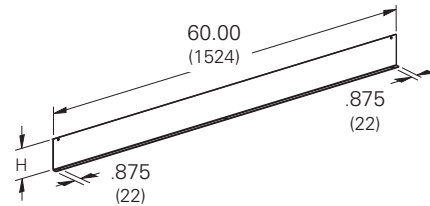

#### Barrier, Bolt-On

- Includes hardware

Catalog Number	Size	H	
		in.	mm
22-12BK	2.5 x 2.5	1.88	48
44-12BK	4 x 4	3.00	76
66-12BK	6 x 6	4.50	114
88-12BK	8 x 8	6.00	152
66-12BK	12 x 6	4.50	114

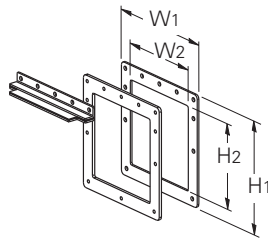

#### Box Connector

- Includes hardware

Catalog Number	Size	H1	H2	W1	W2		
		in.	mm	in.	mm	in.	mm
22-12LBC	2.5 x 2.5	4.10	104	2.35	60	4.10	104
44-12LBC	4 x 4	5.74	146	3.85	72	5.74	146
66-12LBC	6 x 6	7.74	197	5.85	123	7.74	197
88-12LBC	8 x 8	9.74	247	7.85	174	9.74	247
126-12LBC	12 x 6	7.74	197	5.85	123	13.74	301

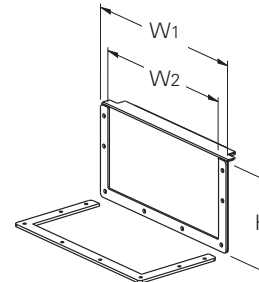

#### Closure Plate

- Includes hardware

Catalog Number	Size	H	W1	W2		
		in.	mm	in.	mm	in.
22-12LCP	2.5 x 2.5	2.50	64	4.00	102	2.50
44-12LCP	4 x 4	4.00	102	5.64	143	4.00
66-12LCP	6 x 6	6.00	152	7.64	194	6.00
88-12LCP	8 x 8	8.00	203	9.64	245	8.00
126-12LCP	12 x 6	6.00	152	13.64	346	12.00

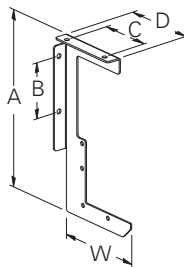

#### Drop

Catalog Number	Size	W	A	B	C	D	
		in.	mm	in.	mm	in.	mm
22-12LDH	2.5 x 2.5	4.50	114	8.75	222	1.50	38
44-12LDH	4 x 4	6.00	152	11.75	298	3.00	76
66-12LDH	6 x 6	8.50	216	16.00	406	5.00	127
88-12LDH	8 x 8	10.50	267	20.00	508	7.00	178

#### Wireway Hangers

- Includes wireway to bracket mounting hardware
- Anchors not included

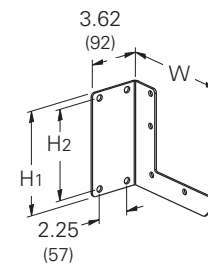

#### Bracket

Catalog Number	Size	H1	H2	W	
		in.	mm	in.	mm
22-12LBH	2.5 x 2.5	3.38	86	2.50	64
44-12LBH	4 x 4	4.88	124	4.00	102
66-12LBH	6 x 6	7.13	181	6.25	159
88-12LBH	8 x 8	9.13	232	8.25	210

Notes: Dimensions are in inches. Millimeters shown are for reference only. Data subject to change without notice.